

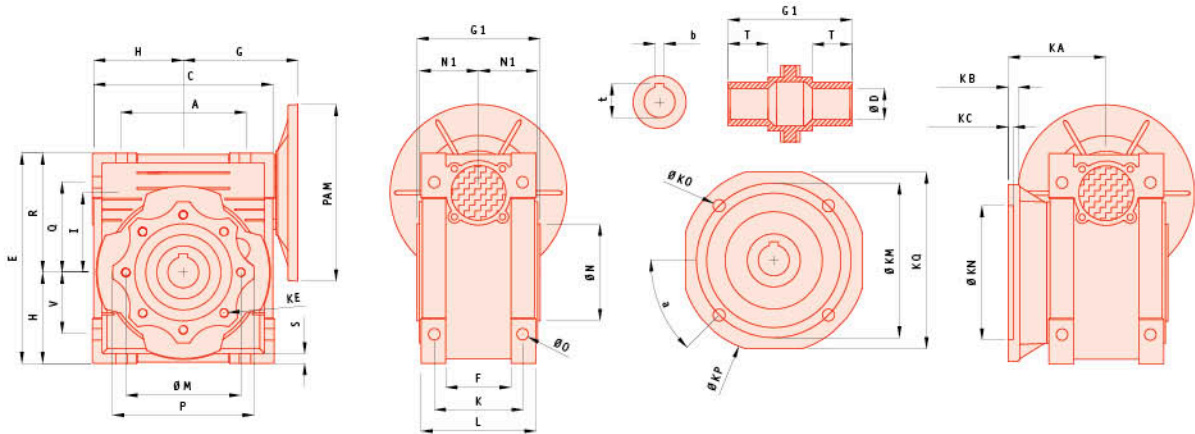

# MSF MOTOREDUCTORES DE VIS SIN FIN MSF SERIES WORM GEARED MOTORS

## DIMENSIONS / OVERALL DIMENSIONS

### MSF 030 - 130



Tamaño Size	A	B	C	D (H7)	E	F	G	G1	H	I	L	M	N (h8)	N1	O	P	Q	R
030	54	20	80	14	97	32	55	63	40	30	56	65	55	29	6.5	75	44	57
040	70	23	100	18 (19)	121.5	43	70	78	50	40	71	75	60	36.5	6.5	87	55	71.5
050	80	30	120	25 (24)	144	49	80	92	60	50	85	85	70	43.5	8.5	100	64	84
063	100	40	144	25 (28)	174	67	95	112	72	63	103	95	80	53	8.5	110	80	102
075	120	50	172	28 (35)	205	72	112.5	120	86	75	112	115	95	57	11	140	93	119
090	140	50	208	35 (32)	238	74	129.5	140	103	90	130	130	110	67	13	160	102	135
110	170	60	252.5	42	295	-	160	155	127.5	110	144	165	130	74	14	200	125	167.5
130	200	80	292.5	45	335	-	180	170	147.5	130	155	215	180	81	16	250	140	187.5

Tamaño Size	S	T	V	K	KA	KB	KC	KE	a	KM	KN (H8)	KO	KP	KQ	b	t	kg
030	5.5	21	27	44	54.5	6	4	M6x11 (4)	45°	68	50	6.5	80	70	5	16.3	1.2
040	6.5	26	35	60	67	7	4	M6x11 (4)	45°	87	60	9	110	95	6 (6)	20.8 (21.8)	2.3
050	7	30	40	70	90	9	5	M8x10 (4)	45°	90	70	11	125	110	8 (8)	28.3 (27.3)	3.5
063	8	36	50	85	82	10	6	M8x14 (8)	45°	150	115	11	180	142	8 (8)	28.3 (31.3)	6.2
075	10	40	60	90	111	13	6	M8x14 (8)	45°	165	130	14	200	170	8 (10)	31.3 (38.3)	9
090	11	45	70	100	111	13	6	M10x18 (8)	45°	175	152	14	210	200	10 (10)	38.3 (41.3)	13
110	14	50	85	115	131	15	6	M10x18 (8)	45°	230	170	14	280	260	12	45.3	35
130	15	60	100	120	140	15	6	M12x21 (8)	22.5°	255	180	16	320	290	14	48.8	48

Para las dimensiones de acoplamiento a motor (cota PAM) consulte la tabla de la página 14.

For dimensions concerning the motor coupling (dimension PAM) please refer to the table on page 14.