

HY series HY038.1-01A

AIR-OIL HEAT EXCHANGERS

IP44

230

Volt

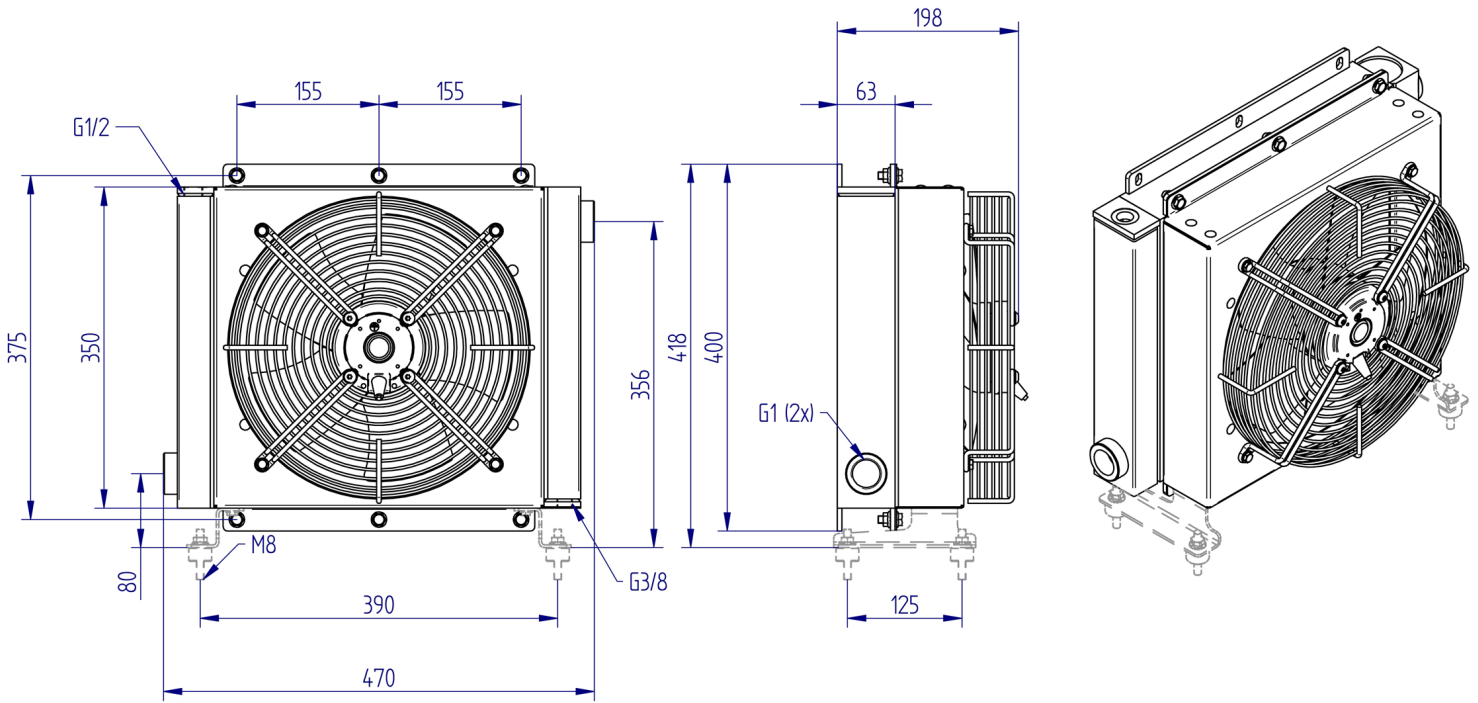

Technical data

Item	Oil flow	Capacity	Weight	Voltage	Frequency	Current absorption	Power	Ø Fan	Air flow	Noise level	Rpm
	[l/min]	[l]	[kg]	[V]	[Hz]	[A]	[W]	[mm]	[m³/h]	[db(A)]	
HY038.1-01A	20-140	2,5	14,5	230	50/60	1,20	280	300	2160	73	

Performance

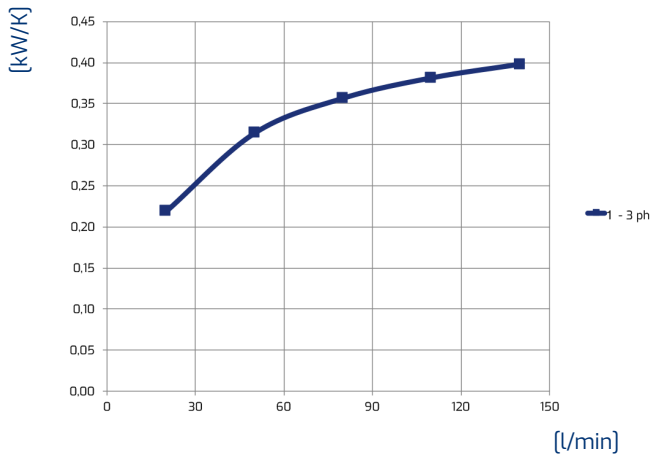

Oil T 80°C
T Amb. 40°C
1 kW = 860 Kcal/h - 1 HP = 0,75 kW

Pressure drop

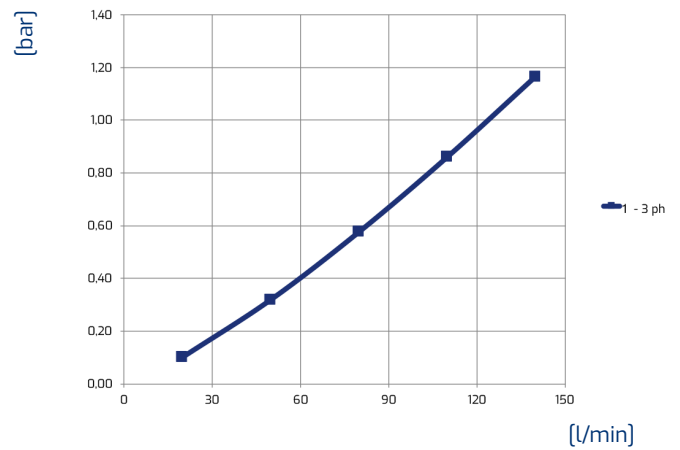

ISO VG 32 at 40°C

Viscosity - ISO VG 32 Oil

Oil	22	32	46	68	150
Correction factor	0,8	1	1,2	1,6	3